

# KARGO MASTER®

WE PUT EVERYTHING WITHIN REACH.

## Cargo Van Racks & Interior Equipment



# FORD

## 2017 PRODUCTS CATALOG

[WWW.KARGOMASTER.COM](http://WWW.KARGOMASTER.COM)  
800-343-7486

# TRANSIT CONNECT ALUMINUM VAN PACKAGES

## COMMERCIAL SHELVING // 43" H Shelves // Compact Cargo Vans

### 400AL PACKAGE

	Part #	Description	Qty
1	#4067A	Partition	1
2	#4862A	62" W x 12" D x 43" H Shelf with 11 Shelf Dividers	1

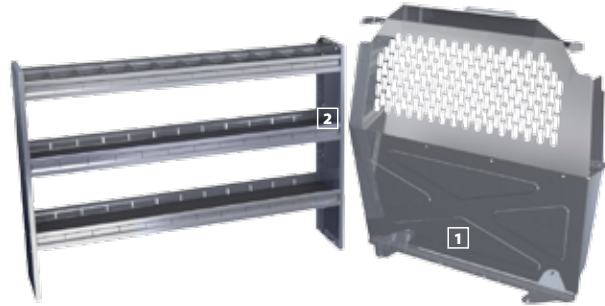

## DELUXE SHELVING // 43" H Shelves // Compact Cargo Vans

### 401AL PACKAGE

	Part #	Description	Qty
1	#4067A	Partition	1
2	#4862A	62" W x 12" D x 43" H Shelf with 11 Shelf Dividers	1
3	#4832A	32" W x 12" D x 43" H Shelf with 5 Shelf Dividers	1
4	#40310	10" W Plastic Shelf Bins	3

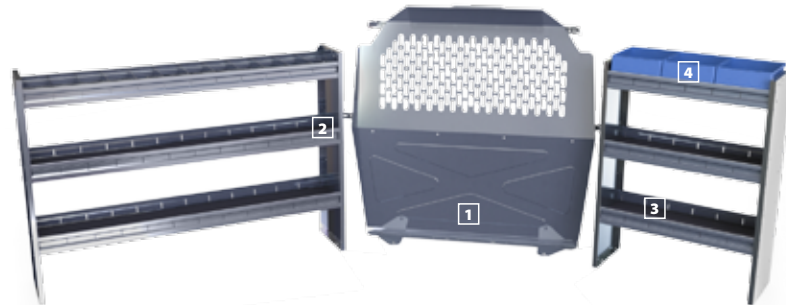

## HVAC // 43" H Shelves // Compact Cargo Vans

### 402AL PACKAGE

	Part #	Description	Qty
1	#4067A	Partition	1
2	#4862A	62" W x 12" D x 43" H Shelf with 11 Shelf Dividers	1
3	#4832A	32" W x 12" D x 43" H Shelf with 5 Shelf Dividers	1
4	#40310	10" W Plastic Shelf Bins	11
5	#40330	5" W Plastic Shelf Bins	12
6	#40200	3-Tier Refrigerant Tank Rack (Steel)	1

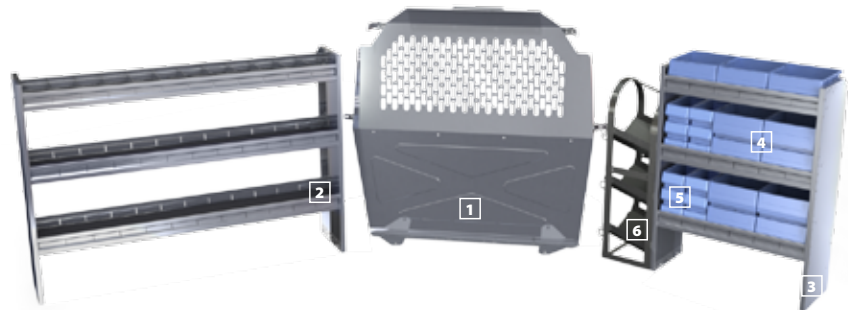

## TELECOM // 43" H Shelves // Compact Cargo Vans

### 403AL PACKAGE

	Part #	Description	Qty
1	#4067A	Partition	1
2	#4862A	62" W x 12" D x 43" H Shelf with 11 Shelf Dividers	1
3	#4832A	32" W x 12" D x 43" H Shelf with 5 Shelf Dividers	1
4	#40310	10" W Plastic Shelf Bins	8
5	#40330	5" W Plastic Shelf Bins	12
6	#4002A	32" W Door Kit	2

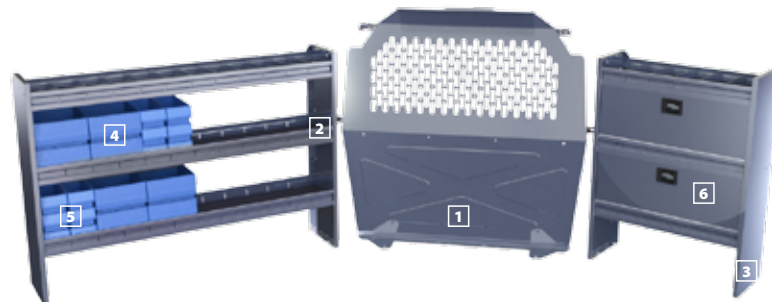

# TRANSIT CONNECT STEEL VAN PACKAGES

## COMMERCIAL SHELVING // 43" H Shelves // Compact Cargo Vans

### 40TCS PACKAGE

	Part #	Description	Qty
1	#40670	Partition	1
2	#4826L	26" W x 14" D x 43" H Shelves	2

### 40TCL PACKAGE

LWB SHOWN

	Part #	Description	Qty
1	#40670	Partition	1
2	#4832L	32" W x 14" D x 43" H Shelves	2



## COMMERCIAL SHELVING (Wire Partition) // 43" H Shelves // Compact Cargo Vans

### 47TCS PACKAGE

	Part #	Description	Qty
1	#40680	Partition	1
2	#4826L	26" W x 14" D x 43" H Shelves	2

### 47TCL PACKAGE

LWB SHOWN

	Part #	Description	Qty
1	#40680	Partition	1
2	#4832L	32" W x 14" D x 43" H Shelves	2

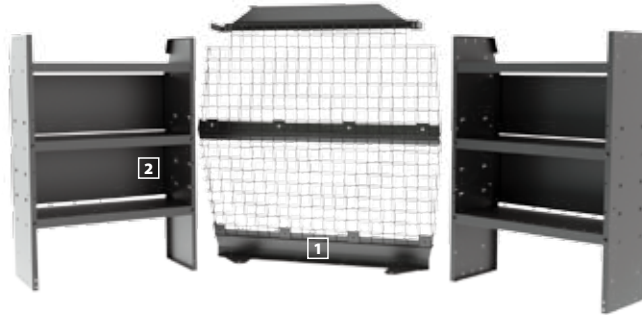

## DELUXE COMMERCIAL SHELVING // 43" H Shelves // Compact Cargo Vans

### 41TCL PACKAGE

	Part #	Description	Qty
1	#40670	Partition	1
2	#4832L	32" W x 14" D x 43" H Shelves	3
3	#40060	3-Prong "J" Hook	1
4	#40030	Shelf Divider (Set of 6)	1

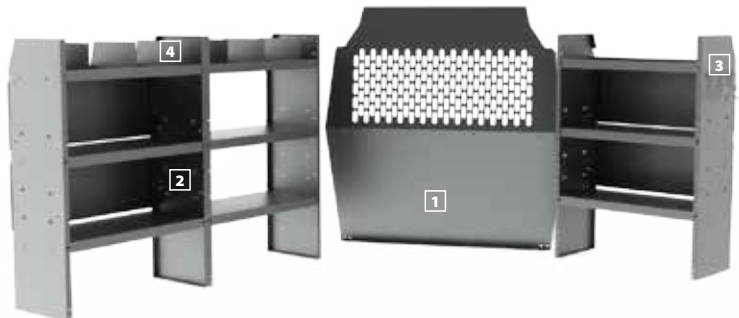

## GENERAL SERVICE // 46" & 43" H Shelves // Compact Cargo Vans

### 41TCS PACKAGE

SWB NOT SHOWN

	Part #	Description	Qty
1	#40670	Partition	1
2	#48420	42" W x 14" D x 46" H Shelf	1
3	#4826L	26" W x 14" D x 43" H Shelf	1
4	#40060	3-Prong "J" Hook	1
5	#48240	Plastic Shelf Bin Module	1
6	#40010	42" W Shelf Door Kit	1
7	#40080	Steel 3 Drawer Cabinet	1

### 42TCL PACKAGE

LWB BASE SHOWN

	Part #	Description	Qty
1	#40670	Partition	1
2	#4832L	32" W x 14" D x 43" H Shelves	4
3	#40060	3-Prong "J" Hook	1
4	#40310	10" W Plastic Shelf Bins	6
5	#40020	32" W Shelf Door Kit	1
6	#40080	Steel 3 Drawer Cabinet	2
7	#48250	Plastic Shelf Bin Modules	2

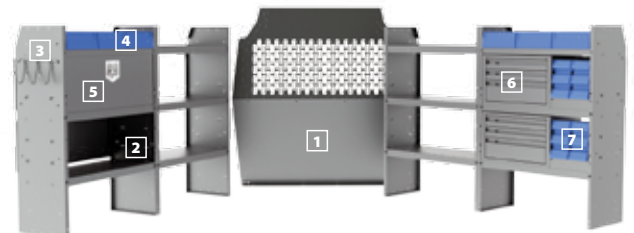



# TRANSIT CONNECT STEEL VAN PACKAGES

## PLUMBING // 43" H Shelves // Compact Cargo Vans

43TCL PACKAGE		
Part #	Description	Qty
1 #40670	Partition	1
2 #4832L	32" W x 14" D x 43" H Shelves	3
3 #40060	3-Prong "J" Hook	1
4 #48250	Plastic Shelf Bin Modules	3
5 #40020	32" W Shelf Door Kit	1
6 #40080	Steel 3 Drawer Cabinets	3
7 #40310	10" W Plastic Shelf Bins	3

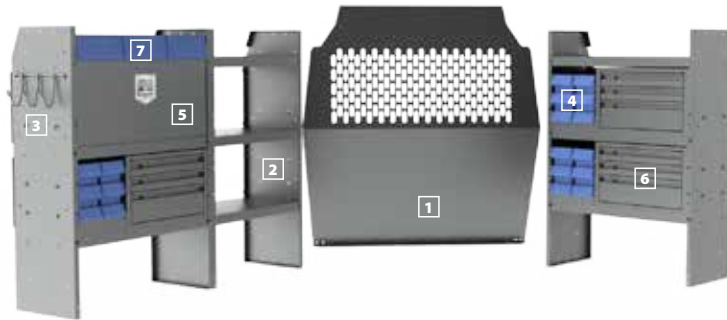

## ELECTRICAL CONTRACTOR // 43" H Shelves // Compact Cargo Vans

44TCL PACKAGE		
Part #	Description	Qty
1 #40670	Partition	1
2 #4832L	32" W x 14" D x 43" H Shelves	3
3 #40060	3-Prong "J" Hook	1
4 #48250	Plastic Shelf Bin Module	1
5 #40020	32" W Shelf Door Kit	1
6 #40080	Steel 3 Drawer Cabinet	1
7 #40310	10" W Plastic Shelf Bins	6

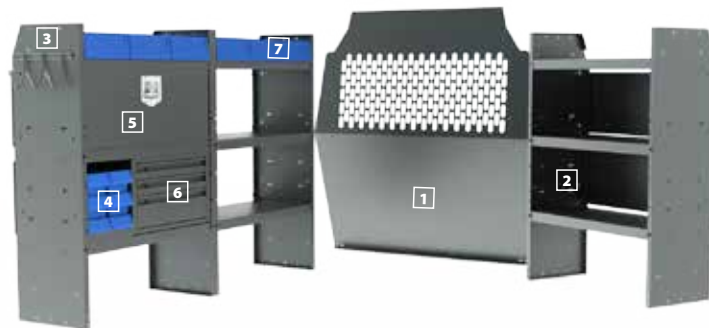

## HVAC // 43" H Shelves // Compact Cargo Vans

45TCL PACKAGE		
Part #	Description	Qty
1 #40670	Partition	1
2 #4832L	32" W x 14" D x 43" H Shelves	3
3 #48250	Plastic Shelf Bin Modules	2
4 #40080	Steel 3 Drawer Cabinets	2
5 #40310	10" W Plastic Shelf Bins	3
6 #40060	3-Prong "J" Hook	1
7 #40200	3-Tier Refrigerant Tank Rack	1

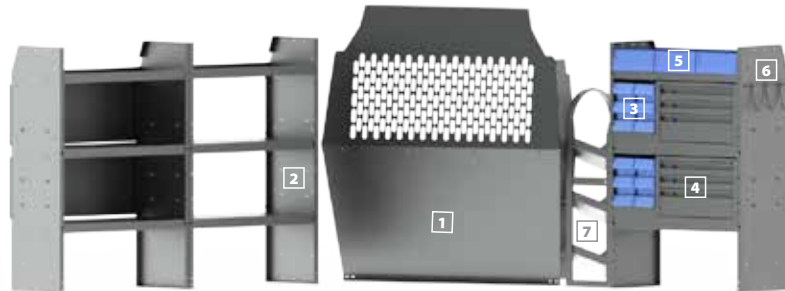

## TELECOM // 43" H Shelves // Compact Cargo Vans

46TCL PACKAGE		
Part #	Description	Qty
1 #40670	Partition	1
2 #4832L	32" W x 14" D x 43" H Shelves	3
3 #40060	3-Prong "J" Hook	1
4 #48250	Plastic Shelf Bin Module	2
5 #40020	32" W Shelf Door Kits	2
6 #40080	Steel 3 Drawer Cabinets	2

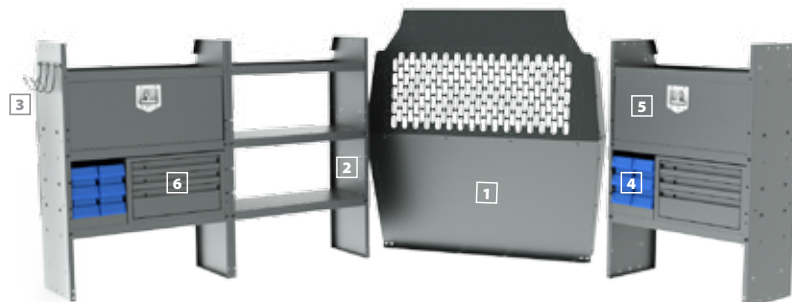

# TRANSIT LOW ROOF STEEL VAN PACKAGES

## BASE // 46" H Shelves

### 40TRL PACKAGE

SWB SHOWN

Part #	Description	Qty
1 #40640 + #406TL	Partition & Wing Kit	1
2 #48420	42" W x 14" D x 46" H Shelves	3

### 40TLL PACKAGE

LWB NOT SHOWN

Part #	Description	Qty
1 #40640 + #406TL	Partition & Wing Kit	1
2 #48520	52" W x 14" D x 46" H Shelves	3



## COMMERCIAL BIN // 46" H Shelves

### 43TRL PACKAGE

Part #	Description	Qty
1 #40640 + #406TL	Partition & Wing Kit	1
2 #48420	42" W x 14" D x 46" H Shelves	3
3 #40030	Shelf Divider (Set of 6)	1
4 #48180	20" L Shelf Lip	1
5 #40080	Steel 3 Drawer Cabinet	1



## GENERAL SERVICE // 46" H Shelves

### 44TRL PACKAGE

SWB SHOWN

Part #	Description	Qty
1 #40640 + #406TL	Partition & Wing Kit	1
2 #48420	42" W x 14" D x 46" H Shelves	3
3 #40060	3-Prong "J" Hook	2
4 #40030	Shelf Divider (Set of 6)	1
5 #40010	42" W Shelf Door Kits	2
6 #40070	Steel 2 Drawer Cabinets	1
7 #40080	Steel 3 Drawer Cabinet	1

### 41TLL PACKAGE

LWB NOT SHOWN

Part #	Description	Qty
1 #40640 + #406TL	Partition & Wing Kit	1
2 #48520	52" W x 14" D x 46" H Shelves	3
3 #40060	3-Prong "J" Hook	2
4 #40030	Shelf Divider (Set of 6)	1
5 #40040	52" W Shelf Door Kits	2
6 #40070	Steel 2 Drawer Cabinets	1
7 #40080	Steel 3 Drawer Cabinet	1
8 #48190	10" L Shelf Lip (Not Shown)	1

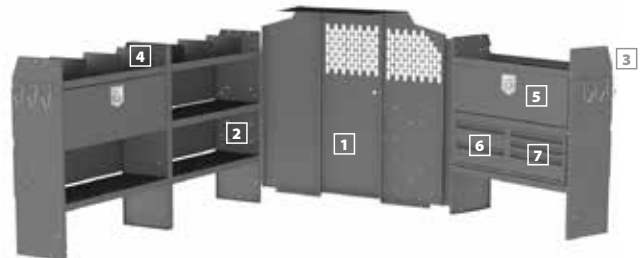

The Kargo Master #40620 Partition Lock and Latch Kit has been improved. It now includes and locking T-handle on the cab side and a sturdy locking bar on the cargo side. It can be installed on any Kargo Master Ram ProMaster Partition.

# TRANSIT LOW ROOF STEEL VAN PACKAGES

## HEATING & A/C REPAIR // 46" H Shelves

### 46TRL PACKAGE

SWB SHOWN

Part #	Description	Qty
1 #40640 + #406TL	Partition & Wing Kit	1
2 #48420	42" W x 14" D x 46" H Shelves	3
3 #40200	3-Tier Refrigerant Tank Rack	1
4 #40030	Shelf Divider (Set of 6)	1
5 #48240	Plastic Shelf Bin Module	1
6 #40010	42" W Shelf Door Kits	2
7 #40070	Steel 2 Drawer Cabinets	2
8 #40080	Steel 3 Drawer Cabinet	1
9 #40060	3-Prong "J" Hook	1

### 45TLL PACKAGE

LWB NOT SHOWN

Part #	Description	Qty
1 #40640 + #406TL	Partition & Wing Kit	1
2 #48520	52" W x 14" D x 46" H Shelves	3
3 #40200	3-Tier Refrigerant Tank Rack	1
4 #40030	Shelf Divider (Set of 6)	1
5 #48240	Plastic Shelf Bin Module	1
6 #40040	52" W Shelf Door Kits	2
7 #40070	Steel 2 Drawer Cabinets	2
8 #40080	Steel 3 Drawer Cabinet	1
9 #40060	3-Prong "J" Hook	1
10 #48190	10" L Shelf Lips (Not Shown)	2



## AMERICA'S MOST POPULAR // 46" H Shelves

### 48TRL PACKAGE

SWB SHOWN

Part #	Description	Qty
1 #40640 + #406TL	Partition & Wing Kit	1
2 #48420	42" W x 14" D x 46" H Shelves	2
3 #48320	32" W x 14" D x 46" H Shelf	1
4 #40280	Standing Binder Rack	1
5 #40220	Cabinet Locker Full Door	1
6 #40080	Steel 3 Drawer Cabinets	2
7 #40060	3-Prong "J" Hook	1
8 #40010	42" W Shelf Door Kit	1

### 47TLL PACKAGE

LWB NOT SHOWN

Part #	Description	Qty
1 #40640 + #406TL	Partition & Wing Kit	1
2 #48520	52" W x 14" D x 46" H Shelves	3
4 #40280	Standing Binder Rack	1
5 #40220	Cabinet Locker Full Door	1
6 #40080	Steel 3 Drawer Cabinets	2
7 #40060	3-Prong "J" Hook	1
8 #40040	52" W Shelf Door Kit	1
9 #48190	10" L Shelf Lips (Not Shown)	1

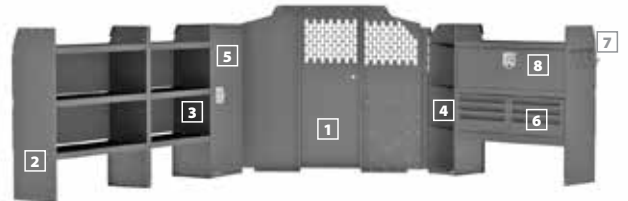

## EZ ALL TRADES // 46" H Shelves

### 49TRL PACKAGE

SWB SHOWN

Part #	Description	Qty
1 #40640 + #406TL	Partition & Wing Kit	1
2 #48420	42" W x 14" D x 46" H Shelves	2
3 #48320	32" W x 14" D x 46" H Shelf	1
4 #40250	56" L 3 Drawer Unit	1
5 #40310	10" W Plastic Bins	4

### 46TLL PACKAGE

LWB NOT SHOWN

Part #	Description	Qty
1 #40640 + #406TL	Partition & Wing Kit	1
2 #48520	52" W x 14" D x 46" H Shelves	3
3 #40250	56" L 3 Drawer Unit	1
4 #40310	10" W Plastic Bins	4

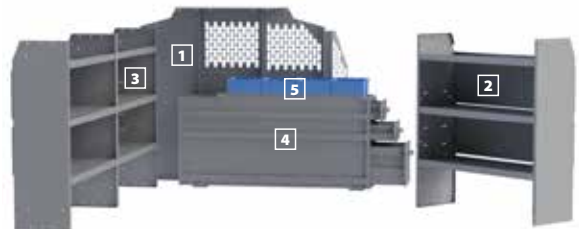

# TRANSIT MID/HIGH ROOF STEEL VAN PACKAGES

## BASE // 60" H Shelves

### 40TRM PACKAGE

SWB SHOWN		
Part #	Description	Qty
1	#40651 + #406TH Partition & Wing Kit	1
2	#48424 42" W x 14" D x 60" H Shelves	3

### 40TLM PACKAGE

LWB NOT SHOWN		
Part #	Description	Qty
1	#40651 + #406TH Partition & Wing Kit	1
2	#48524 52" W x 14" D x 60" H Shelves	3



## GENERAL SERVICE // 60" H Shelves

### 41TRM PACKAGE

SWB SHOWN		
Part #	Description	Qty
1	#40651 + #406TH Partition & Wing Kit	1
2	#48424 42" W x 14" D x 60" H Shelves	3
3	#40060 3-Prong "J" Hooks	2
4	#40030 Shelf Divider (Set of 6)	1
5	#40310 Plastic Shelf Bins	4
6	#40080 Steel 3 Drawer Cabinet	1
7	#40090 Steel 4 Drawer Cabinet	1

### 41TLM PACKAGE

LWB NOT SHOWN		
Part #	Description	Qty
1	#40651 + #406TH Partition & Wing Kit	1
2	#48524 52" W x 14" D x 60" H Shelves	3
3	#40060 3-Prong "J" Hooks	2
4	#40030 Shelf Divider (Set of 6)	1
5	#40310 Plastic Shelf Bins	5
6	#40080 Steel 3 Drawer Cabinet	1
7	#40090 Steel 4 Drawer Cabinet	1
8	#48190 10" L Shelf Lip (Not Shown)	1



## HVAC // 60" H Shelves

### 45TRM PACKAGE

SWB SHOWN		
Part #	Description	Qty
1	#40651 + #406TH Partition & Wing Kit	1
2	#48424 42" W x 14" D x 60" H Shelves	3
3	#40200 3-Tier Refrigerant Tank Rack	1
4	#40030 Shelf Divider (Set of 6)	1
5	#40310 Plastic Shelf Bins	4
6	#40010 42" W Shelf Door Kit	1
7	#40270 Hanging File Rack	1
8	#40070 Steel 2 Drawer Cabinets	2
9	#40060 3-Prong "J" Hook	1

### 45TML PACKAGE

LWB NOT SHOWN		
Part #	Description	Qty
1	#40651 + #406TH Partition & Wing Kit	1
2	#48524 52" W x 14" D x 60" H Shelves	3
3	#40200 3-Tier Refrigerant Tank Rack	1
4	#40030 Shelf Divider (Set of 6)	1
5	#40310 Plastic Shelf Bins	5
6	#40040 52" W Shelf Door Kit	1
7	#40270 Hanging File Rack	1
8	#40070 Steel 2 Drawer Cabinets	2
9	#40060 3-Prong "J" Hook	1
10	#48190 10" L Shelf Lip	1



The Kargo Master #40620 Partition Lock and Latch Kit has been improved. It now includes and locking T-handle on the cab side and a sturdy locking bar on the cargo side. It can be installed on any Kargo Master Ram ProMaster Partition.



# TRANSIT MID/HIGH ROOF STEEL VAN PACKAGES

## ELECTRICAL CONTRACTOR // 60" H Shelves

42TRM PACKAGE			42TLM PACKAGE		
SWB SHOWN			LWB NOT SHOWN		
Part #	Description	Qty	Part #	Description	Qty
1	#40651 + #406TH Partition & Wing Kit	1	1	#40651 + #406TH Partition & Wing Kit	1
2	#48424 42" W x 14" D x 60" H Shelves	3	2	#48524 52" W x 14" D x 60" H Shelves	3
3	#40230 5 Spindle Wire Reel Holder	1	3	#40230 5 Spindle Wire Reel Holder	1
4	#40030 Shelf Divider (Set of 6)	1	4	#40030 Shelf Divider (Set of 6)	1
5	#40310 10" W Plastic Shelf Bins	8	5	#40310 10" W Plastic Shelf Bins	10
6	#40010 42" W Shelf Door Kits	2	6	#40040 42" W Shelf Door Kits	2
7	#40270 Hanging File Rack	1	7	#40270 Hanging File Rack	1
8	#40090 Steel 4 Drawer Cabinets	2	8	#40090 Steel 4 Drawer Cabinets	2
9	#40060 3-Prong "J" Hook	1	9	#40060 3-Prong "J" Hook	1
			10	#48190 10" L Shelf Lip (Not Shown)	1



## SECURITY // 60" H Shelves

43TRM PACKAGE			43TLM PACKAGE		
SWB SHOWN			LWB NOT SHOWN		
Part #	Description	Qty	Part #	Description	Qty
1	#40651 + #406TH Partition & Wing Kit	1	1	#40651 + #406TH Partition & Wing Kit	1
2	#48424 42" W x 14" D x 60" H Shelves	3	2	#48524 52" W x 14" D x 60" H Shelves	3
3	#40030 Shelf Dividers (Set of 6)	2	3	#40030 Shelf Dividers (Set of 6)	2
4	#40310 10" W Plastic Shelf Bins	4	4	#40310 10" W Plastic Shelf Bins	5
5	#40010 42" W Shelf Door Kits	2	5	#40040 52" W Shelf Door Kits	2
6	#40270 Hanging File Rack	1	6	#40270 Hanging File Rack	1
7	#40070 Steel 2 Drawer Cabinets	2	7	#40070 Steel 2 Drawer Cabinets	2
8	#40060 3-Prong "J" Hook	2	8	#40060 3-Prong "J" Hook	2
			9	#48190 10" L Shelf Lip (Not Shown)	1



## EZ ALL TRADES // 60" H Shelves

46TRM PACKAGE			46TLM PACKAGE		
SWB SHOWN			LWB NOT SHOWN		
Part #	Description	Qty	Part #	Description	Qty
1	#40651 + #406TH Partition & Wing Kit	1	1	#40651 + #406TH Partition & Wing Kit	1
2	#48424 42" W x 14" D x 60" H Shelves	2	2	#48524 52" W x 14" D x 60" H Shelves	3
3	#48324 32" W x 14" D x 60" H Shelf	1	3	#40250 56" L 3 Drawer Unit	1
4	#40250 56" L 3 Drawer Unit	1	4	#40310 10" W Plastic Bins	4
5	#40310 10" W Plastic Bins	4			

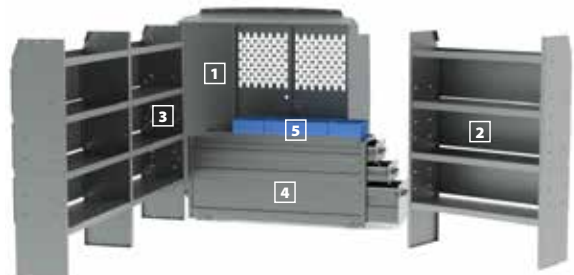



# PRODUCTS FEATURED IN OUR FORD PACKAGES

For complete details on all parts in this catalog, please visit [www.kargomaster.com](http://www.kargomaster.com).

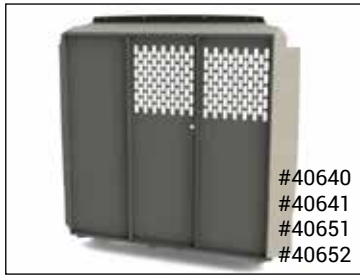

#40640  
#40641  
#40651  
#40652

**Steel Partition**

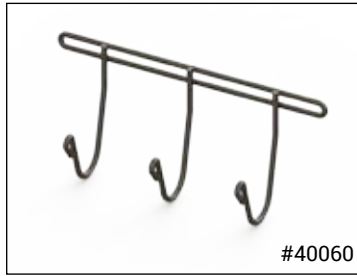

#40060

**Compact Van Wire Partition**



#4826L  
#4832L  
#48320  
#48324  
#48420  
#48520

**Adjustable Steel Shelves**



#40010  
#40020  
#40040

**Shelf Door Kits**



#40070  
#40080  
#40090

**Steel Drawer Cabinets**

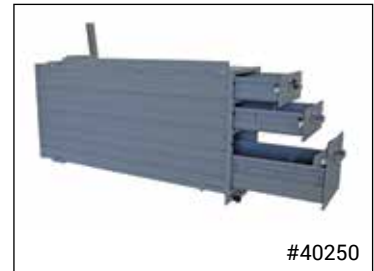

#40250

**56" Heavy Duty 3 Drawer Unit**

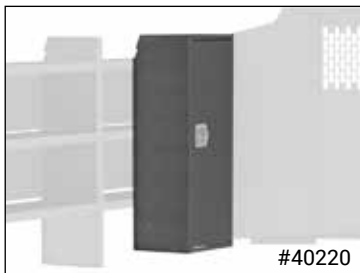

#40220

**46" Tall Cabinet Locker**



#40100  
#40200

**Refrigerant Tank Racks**



#40280

**Standing Binder Rack**



#40230

**Wire Reel Holder**



#40270

**Hanging File Rack**

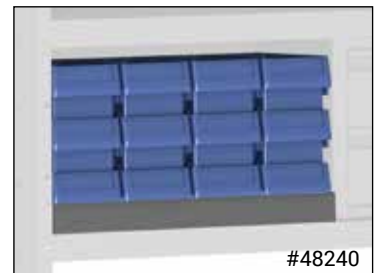

#48240

**Plastic Bin Modules**



#4067A

**Aluminum Van Partition**



#4832A  
#4862A

**Adjustable Aluminum Shelves**



#4002A

**Aluminum Shelf Door Kit**

# TRANSIT & TRANSIT CONNECT ROOF RACKS



**Clamp & Lock** #40873 & #40813 Shown



**RETRACTABLE RATCHET STRAPS**  
#40830

**2 Crossbar Rack** #40821 & #40829 Shown

Kargo Master Retractable Ratchet Straps #31500 & #40830 are an essential component of any Crossbar Rack, whether one is carrying ladders, cargo, or both. We highly recommend the purchase of these accessories in order to maximize the functionality and usefulness of a rack, as well as provide safety for the cargo, the vehicle and the road.



**EZ Drop Down** #4097M Shown

For complete details on all van racks, please visit [www.kargomaster.com](http://www.kargomaster.com).

## TRANSIT CONNECT **Mount Kits Included**

Part #	Description
#40873	Clamp & Lock <b>Single</b>
#40873 + #40813	Clamp & Lock <b>Double</b>
#40933	EZ Drop Down <b>Single</b>
#40933 + #40943	EZ Drop Down <b>Double</b>
#40933 + #40813	EZ Drop Down <b>Combo Rack</b>
#80070	4 Tube Cargo & Ladder Rack with Protective Rear Bar (Includes Wind Deflector)
#31500	Retractable Ratchet Straps (Pair) - 1" x 6' - Mount Brackets Included Fits #80070/80080
#40819	2 Crossbar Rack Kit with 2 Retractable Ratchet Straps (#40830) - Includes Wind Deflector
#40821	2 Crossbar Rack - Includes Wind Deflector
#40822	Add a 3rd Middle Crossbar to #40821
#40830	Retractable Ratchet Straps (Pair) 1" x 6' Fits #40821 & #40822

## LOW ROOF TRANSIT

**Must Order Mount Kit Shown in Red**

#40903	Clamp & Lock <b>Single</b>
#40903 + #40813	Clamp & Lock <b>Double</b>
#4092L	EZ Drop Down <b>Single</b> + #4081T Mount
#4092L + #40963	EZ Drop Down <b>Double</b> + #4081T Mount
#4092L + #40813	EZ Drop Down <b>Combo Rack</b> + #4081T Mount
#80080	5 Tube Cargo & Ladder Rack with Protective Rear Bar - Includes Wind Deflector
#31500	Retractable Ratchet Straps (Pair) - 1" x 6' - Mount Brackets Included Fits #80070/80080
#40819	2 Crossbar Rack with #40830 (See Below) Includes Wind Deflector
#40821	2 Crossbar Rack - Includes Wind Deflector
#40822	Add a 3rd Middle Crossbar to #40821
#40829	Rear Roller Bar (Recommended with #40821 & #40819)
#40830	Retractable Ratchet Straps (Pair) 1" x 6' - Mounts to Crossbar End Plate Fits #40821 & #40822

## MID ROOF TRANSIT

**Must Order Mount Kit Shown in Red**

#4097M	EZ Drop Down <b>Single</b> + #4081T Mount
#4097M + #40983	EZ Drop Down <b>Double</b> + #4081T Mount
#80080	5 Tube Cargo & Ladder Rack with Protective Rear Bar - Includes Wind Deflector
#31500	Retractable Ratchet Straps (Pair) - 1" x 6' - Mount Brackets Included Fits #80070/80080
#4099T	*EZ Drop Down <b>Single</b>
#4099T + #40913	*EZ Drop Down <b>Double</b>
#40993	*EZ Drop Down <b>Single</b>
#40993 + #40913	*EZ Drop Down <b>Double</b>

\*These racks allow for easier operation as the ladder bed has greater travel and positions the ladder lower than the 4097M.

## HIGH ROOF TRANSIT **Mount Kits Included**

#4099T	EZ Drop Down <b>Single</b>
#4099T + #40913	EZ Drop Down <b>Double</b>
#40993	EZ Drop Down <b>Single</b>
#40993 + #40913	EZ Drop Down <b>Double</b>

# FORD TRUCK RACKS

For more information on all Kargo Master truck racks, visit [www.kargomaster.com](http://www.kargomaster.com).



**Super-Duty Pro II** Pick Up Truck Cargo Racks

SUPER-DUTY STEEL CARGO RACK FOR FULL-SIZED TRUCKS (2" DIA.) – BLACK ONLY

Part #	Description
#04000+#01000	Standard Cab – Long Bed (F-150)
#06000+#01000	Extended Cab/Crew Cab – Long Bed (F-150)
#06010+#01000	Extended Cab/Crew Cab – Short Bed 75" to 78" (F-150)
#04000+#01040	Standard Cab – Long Bed (F-250, F-350)
#06000+#01040	Extended Cab/Crew Cab – Long Bed (F-250, F-350)
#06010+#01040	Extended Cab/Crew Cab – Short Bed 75" to 78" (F-250, F-350)
#31600	Optional Extra Crossbar

HEAVY-DUTY CARGO RACK FOR FULL-SIZED TRUCKS (2" DIA.) FOR TRUCKS WITH SHELL BLACK ONLY

#04000+#01110	Standard Cab – Long Bed (F-150)
#06000+#01110	Extended Cab/Crew Cab – Long Bed (F-150)
#06010+#01110	Extended Cab/Crew Cab – Short Bed 75" to 78" (F-150)
#06000+#01130	Extended Cab/Crew Cab – Long Bed (F-250 SD, F-350 SD)



**Medium-Duty Pro IV** Pick Up Truck Cargo Racks

MEDIUM-DUTY ALUMINUM CARGO RACK FOR FULL-SIZED TRUCKS (2" DIA.) – SILVER ONLY

Part #	Description
#90000	All Full-Sized
#31690	Optional Extra Crossbar



**Medium-Duty Pro III** Pick Up Truck Cargo Racks

MEDIUM-DUTY STEEL CARGO RACK FOR FULL-SIZED TRUCKS (1-5/8" DIA.) – BLACK ONLY

Part #	Description
#80000	All Full-Sized - For Trucks without Shell
#31110	Optional Extra Crossbar

MEDIUM-DUTY STEEL CARGO RACK FOR MID-SIZED TRUCKS (1-5/8" DIA.) FOR TRUCKS WITH SHELLS

#80030	All Mid-Sized (Ford) - Black Only
#80070	Top Rack Mount (Also Fits Ford Transit Connect Cargo Van) - Silver - Includes Wind Deflector



**Heavy-Duty Pro II** for Trucks with Service Bodies

LADDER RACKS FOR SERVICE BODIES SINGLE AND DUAL REAR WHEEL

Part #	Description
#78000+#70020	Standard Cab – 8' Body – Black
#78003+#70023	Standard Cab – 8' Body – White
#78010+#70020	Extended Cab – 8' Body – Black
#78013+#70023	Extended Cab – 8' Body – White
#79000+#70020	Standard Cab – 9' Body – Black Only
#79010+#70020	Extended Cab – 9' body – Black Only
#79010+#70020	Standard Cab – 11' Body – Black Only



**New improved mounting kit included in all Pro II Service Body Racks.**

Kargo Master racks are also available for trucks with work tops and platform bodies. For more information, visit [www.kargomaster.com](http://www.kargomaster.com).





WE PUT EVERYTHING WITHIN REACH.

# Cargo Van Racks & Interior Equipment

# FORD 2017 PRODUCTS CATALOG

### Industry Best Warranty

#### LIFETIME STRUCTURAL WARRANTY

If your product cracks, bends, or structurally fails in any way, Kargo Master, at its option and expense, will either replace or repair the product.

#### 3 YEAR COMPONENT WARRANTY

If any synthetic (e.g. rubber or nylon) or hydraulic (e.g. gas shock) component of your product fails within 3 years of purchase, Kargo Master will provide a replacement component at no cost to you.



CALL US  
**800-343-7486**



○ **HEADQUARTERS**

11253 TRADE CENTER DR., SUITE G  
RANCHO CORDOVA, CA 95742

**WEST COAST WAREHOUSE**

2587 MERCANTILE DR.  
RANCHO CORDOVA, CA 95742



**Facebook**  
<https://facebook.com/kargomaster>

DISTRIBUTED BY: