

HEAVY-DUTY STEEL & ALUMINUM DRAWER SYSTEMS



Heavy-Duty Steel Drawer System

500 lb. Rated Slides - Drawer slides are rated to hold up to the rigors of heavy-duty use and will support heavy tools and other equipment. Drawer slides and hardware carry a full lifetime warranty.

Galvanized Steel Construction (nothing beats solid steel for rugged, off road use) - All drawer components are manufactured of galvanized steel to prevent rust and provide a virtually indestructible surface for the latches to strike-no worn paint as on other manufacturer's product. The metal edges of the drawers, and top shelf, are hemmed for added strength and safety.

Heavy-Duty Aluminum Drawer System

500 lb. Rated Slides - Drawer slides are rated to hold up to the rigors of heavy-duty use and will support heavy tools and other equipment. Drawer slides and hardware carry a full lifetime warranty.

Galvanized Steel Enclosure - All drawer enclosure and mechanism components are manufactured of galvanized steel for superior strength and corrosion resistance.

Aluminum Drawers - All drawers are constructed of lightweight aluminum for weight savings and corrosion resistance.

Drawer Liner - Non-slip drawer liner is perfect for protection of valuable tools and helps keep them in place for better organization.

Lighter - Approximately 40% lighter than steel counterpart.

Light Weight Aluminum Drawer System

250 lb. Rated Slides - Drawer slides are rated to hold up to the rigors of standard-duty use and will endure years of service. Drawer slides and hardware carry a full lifetime warranty.

Aluminum Enclosure - All drawer enclosures are constructed of aluminum for superior strength and corrosion resistance.

Aluminum Drawers - All drawers are constructed of lightweight aluminum for weight savings and corrosion resistance.

Drawer Liner - Non-slip drawer liner is perfect for protection of valuable tools and helps keep them in place for better organization.

Lighter - Approximately 50% lighter than steel counterpart.



AMERICAN EAGLE® DRAWER SYSTEMS

Standard features for all drawer systems

- Individual Locking Drawers - all of the drawers on an American Eagle® drawer system have individual locks. Drawer locks may even be keyed differently upon request.
- "T" Handle - this feature provides a one-handed operation and conceals the lock mechanism for heavy-duty protection and an attractive appearance.
- Powder Coated Drawer Fronts - powder coated drawer fronts offer superior, heavy-duty protection and an attractive finish.
- Removable Drawers - individual drawers are easily removed to assist in installation. This feature also offers the convenience of moving items closer to the job or retrieving a lost tool.
- Dividers are included in each drawer for tool organization.
- Telescoping top shelf for easy installation. (A space-saving flat top is also available).
- Standard 2.50" riser built-in with slotted mounting holes for quick installation. (No riser or special riser kits available).
- Concealed latching hardware and latch-guard for durability and security.

Optional features



Custom Colors

Match the color scheme of your service truck.



Egg Crate Dividers

Useful for small parts storage.

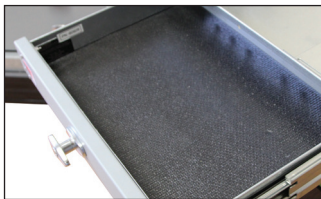

Drawer Liner

Non-slip drawer liner is perfect for protection of valuable tools and helps keep them in place for better organization. (Standard on all aluminum systems)

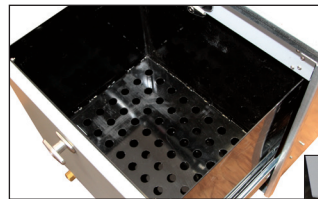

Oil Filter/Drain Drawer

Includes an integrated drain valve on the bottom of the drawer. (Custom sizes and configurations are available).

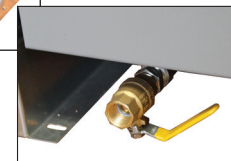

American Eagle Drawer Systems are manufactured by American Eagle in Garner, Iowa. American Eagle is known for bringing some of the greatest advances into the truck accessory market.



What work trucks are built around.

740 North State Street
P.O. Box 169
Garner, IA 50438
Telephone: 641-923-2425 • 800-392-3015
Fax: 641-923-9099
Internet: www.americaneagleacc.com
E-mail: sales@americaneagleacc.com

Designed & Manufactured in the U.S.A.

*Specifications may change without notification.
Copyright © 2016 American Eagle Accessories Group.

ALUMINUM BOLT BINS



American Eagle aluminum bolt bins are an excellent storage system for nuts, bolts, fittings, and more!

- Completely constructed of heavy gauge aluminum for durability and weight savings.
- Built-in pull style handle for easy access.
- Angled base ensures that bins remain in, except when accessed.
- Simple bolt-down construction for rigidity and quick installation – ready-to-use right out of the box.
- Each bin includes 3 removable aluminum dividers, so each bin can be custom configured.
- Many standard configurations to choose from. Custom units are also available to fit your needs.
- Standard bins are the following dimensions:
 - 4 1/8"H x 6 3/4"W x 17 1/4"D
 - 4 1/8"H x 6 3/4"W x 13 1/4"D
 - 4 1/8"H x 6 3/4"W x 11 1/4"D

AMERICAN EAGLE ALUMINUM BOLT BINS

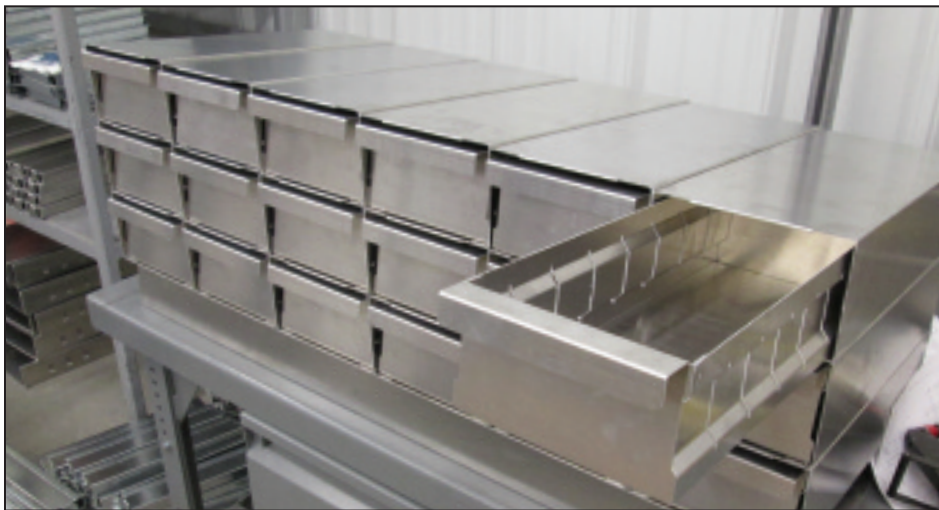

What work trucks are built around.

740 North State Street
P.O. Box 169
Garner, IA 50438
Telephone: 641-923-2425 • 800-392-3015
Fax: 641-923-9099
Internet: www.americaneagleacc.com
E-mail: sales@americaneagleacc.com

Designed & Manufactured in the U.S.A.

*Specifications may change without notification.
Copyright © 2015 American Eagle Accessories Group.

Your local distributor:

AMERICAN EAGLE®

DRAWER SYSTEMS

***Design the drawer system how you want it...
and we'll make it!***

What we can do for you:

- 12" – 50" wide (in even inch increments)
- 10" – 76" deep (in even inch increments)
- Drawer heights of 3", 5" and 7"
- Standard 2.5" riser height

Options:

- No riser and special riser kits
- Space saving flat top
- Egg crate dividers
- Full enclosures with casters
- Hinged work top trays
- Special hanging configurations
- Quick design and manufacturing lead-time

Other ideas? Call us! We are here to make your job easier!

A drawer set measurement guide is available on the website: www.americaneagleacc.com



*What work trucks
are built around.*

740 N. State Street

P.O. Box 169

Garner, IA 50438

Telephone: (641) 923-2425 • (800) 392-3015

Fax: (641) 923-9099

Internet: www.americaneagleacc.com

Email: sales@americaneagleacc.com

Specifications may change without notification.

The American Eagle logo is registered in the U.S. Patent and Trademark Office.

Copyright © 2015 American Eagle Accessories Group

8/15 STL000099



AMERICAN EAGLE® DRAWER SYSTEMS

American Eagle® drawer systems are engineered to withstand extreme levels of use and abuse!

- Certified* 500 lb. rated heavy-duty slides for durability and effortless operation.
- Standard and custom sizes and configurations available.
- All steel construction for superior strength and long life.
- Drawer fronts are powder-coated gray for a great looking, long lasting finish.
(Custom colors are available for an extra charge).
- All unpainted components are galvanized for rust free durability (and no chipped paint like many competitive units).
- Ergonomic T-shaped handles for convenient one-handed operation. All handles are key-lockable for security.
- Easy installation.
- Designed and manufactured by American Eagle, an employee owned company located in Garner, Iowa.
- Lifetime warranty on slides and hardware.



**Certified by SGS, a leading inspection, verification, and certification company.*

Designed & Manufactured
in the USA



WHY AMERICAN EAGLE® DRAWERS SHOULD BE YOUR CHOICE

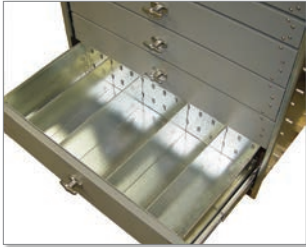

Four dividers are included in each drawer for tool organization.



Galvanized components with powder coated drawer fronts for appearance and durability.



Telescoping top shelf for easy installation. *(A space-saving flat top is also available).*



Removable drawers for:

1. Ease of installation.
2. Move tools closer to your work.
3. Quick retrieval of lost or jammed tools.



Drawer edges are hemmed for added strength.

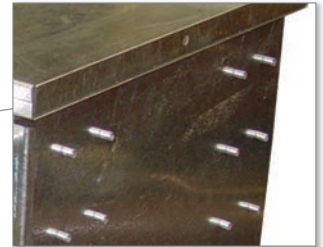
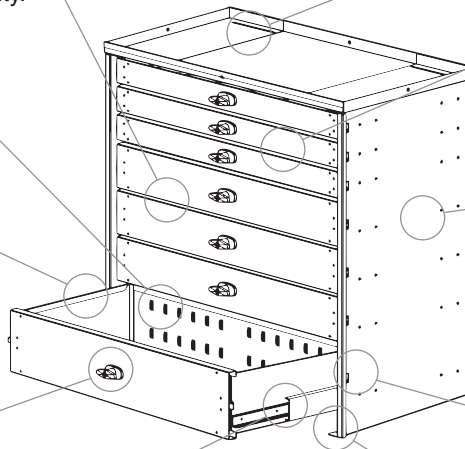

Heavy-duty 14-gauge steel sides for durability.



Single handed T-shaped latch for convenient one-handed access. All drawers are keyed for security.

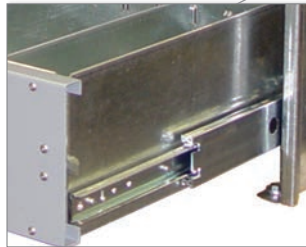

Certified* heavy-duty 500 lb. drawer slides for superior strength.



Standard 2.50" riser built-in with slotted mounting holes for quick installation. *(No riser or special riser kits available).*



Concealed latching hardware and latch-guard for durability and security.

Drawer System Options

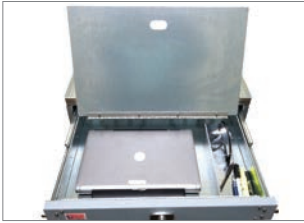

Hinged Drawer Lid

Useful for the storage of paperwork, laptop, or other valuables. It also provides a sturdy work surface for assembling or sorting.



Egg Crate Dividers

Useful for small parts storage.

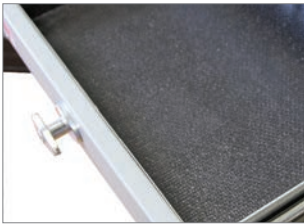

Drawer Liner

Non-slip drawer liner is perfect for protection of valuable tools and helps keep them in place for better organization.

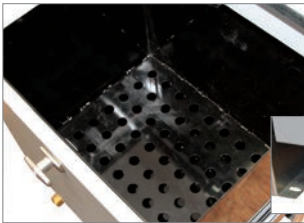

Oil Filter/Drain Drawer

Includes an integrated drain valve on the bottom of the drawer. *(Custom sizes and configurations are available).*



Custom Colors

Match the color scheme of your service truck.

Shop Tool Box

Need a drawer system for your shop?

A heavy-duty enclosure is available.



- 10-gauge powder-coated gray steel top for long life and to use as a work surface or shelf.
- Heavy-duty galvanized steel side and back panels for a strong attractive finish.
- Four heavy-duty (700 lb.) casters for easy rolling and durability.

Bolt Bins

American Eagle® bolt bin units are an excellent storage system for nuts, bolts, fittings, and more!

- Constructed of heavy 16-gauge steel – more than twice the thickness of similar competitive units.
- Entire units, inside and out, are painted with chip-resistant powder paint for an attractive appearance and superior durability.
- Each bin includes 3 removable aluminum dividers (7 slots per drawer) for custom configuration.
- Many standard and custom configurations.
- Bins measure 4-1/8" H x 6-3/4" W x 17-1/4" D for plenty of storage room.

